

## Introductie

Als u op zoek bent naar een strakke en modere uitstraling, dan is het roestvrijstalen hang- en sluitwerk wellicht iets voor u. Jobé heeft zowel duimen en hengen als luiksluiters en -vastzetters van RVS in A2 en A4 kwaliteit.

Dankzij haar duurzame eigenschappen is het roestvrijstalen beslag ook zeer geschikt in corrosie gevoelige omgevingen, zoals bij zee.



# RVS Luikbeslag



# 5. RVS luikbeslag

## Kenmerken

- *Materiaal RVS A2 en A4*
- *Duimdiameter: 13mm (A2) en 14mm (A4)*
- *Zeer duurzaam*
- *Ook gepoedercoat verkrijgbaar*
- *Maatwerk binnen twee weken leverbaar*
- *Snelle levering door ruime voorraad*



# Duimen

## Inschroefduim RVS A2



| Artikelcode | D (mm) | Afwerking |
|-------------|--------|-----------|
| 051.01.01   | 13     | RVS A2    |
| 051.01.02   | 16     | RVS A2    |

## Plaatduim RVS A2

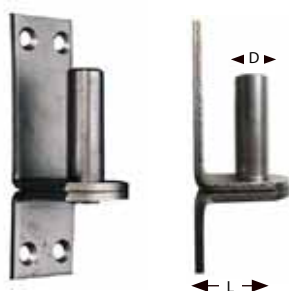

| Artikelcode | L (mm) | D (mm) | Gat (mm) Ø | Afwerking |
|-------------|--------|--------|------------|-----------|
| 100 x 40 mm |        |        |            |           |
| 051.02.01   | 28     | 13     | 4x7        | RVS A2    |
| 120 x 45 mm |        |        |            |           |
| 051.02.02   | 28     | 16     | 4x7        | RVS A2    |

## Inschroefduim RVS A4

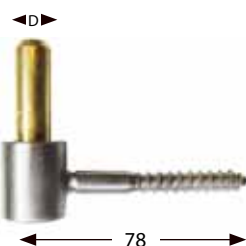

| Artikelcode | D (mm) | Afwerking |
|-------------|--------|-----------|
| 051.03.01   | 14     | RVS A4    |
| 051.03.02   | 16     | RVS A4    |

## Plaatduim RVS A4

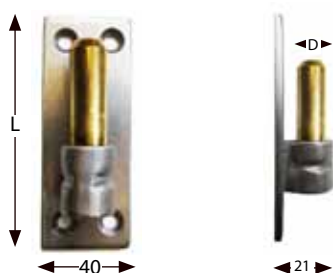

| Artikelcode | L (mm) | D (mm) | Gat (mm) Ø | Afwerking |
|-------------|--------|--------|------------|-----------|
| 40 x 4 mm   |        |        |            |           |
| 051.04.01   | 100    | 14     | 4x6        | RVS A4    |
| 051.04.02   | 180    | 16     | 4x6        | RVS A4    |

## Plaatduim (muurmontage) RVS A4

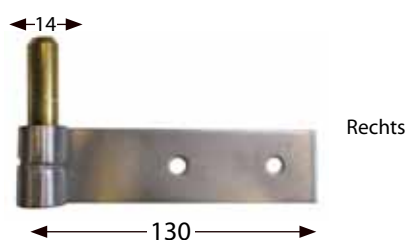

| Artikelcode | L/R | Gat (mm) Ø | Afwerking |
|-------------|-----|------------|-----------|
| 35 x 4 mm   |     |            |           |
| 051.05.01   | L   | 2x7        | RVS A4    |
| 051.05.02   | R   | 2x7        | RVS A4    |

# Gehengen

## Staartgeheng RVS A2



| Artikel-<br>code | L<br>(mm) | D<br>(mm) | Gat □<br>(mm) Ø | Afwerking |
|------------------|-----------|-----------|-----------------|-----------|
| 40 x 4 mm        |           |           |                 |           |
| 052.01.01        | 400       | 13        | 9 / 2x7         | RVS A2    |
| 052.01.02        | 500       | 13        | 9 / 3x7         | RVS A2    |
| 052.01.03        | 600       | 13        | 9 / 3x7         | RVS A2    |
| 45 x 5 mm        |           |           |                 |           |
| 052.01.04        | 400       | 16        | 11 / 2x9        | RVS A2    |
| 052.01.05        | 600       | 16        | 11 / 3x9        | RVS A2    |
| 052.01.06        | 800       | 16        | 11 / 4x9        | RVS A2    |
| 052.01.07        | 1000      | 16        | 11 / 4x9        | RVS A2    |

## L-deel (per paar, excl. duimdelen) RVS A2

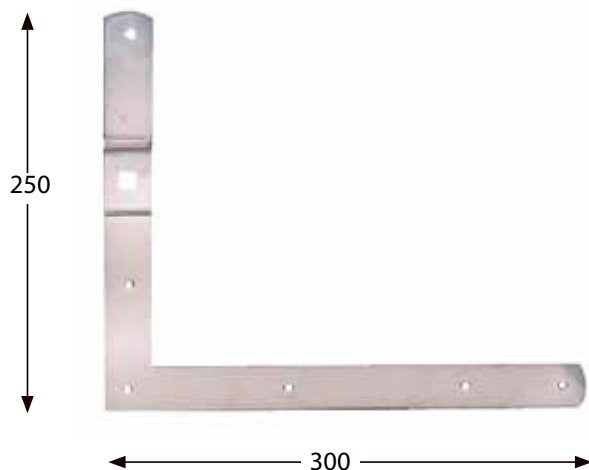

| Artikelcode | Gat □ (mm) Ø | Afwerking |
|-------------|--------------|-----------|
| 30 x 3 mm   |              |           |
| 052.02.01   | 9 / 6 x 5,5  | RVS A2    |

## T-deel (excl. duimdeel) RVS A2



| Artikelcode | Gat □ (mm) Ø | Afwerking |
|-------------|--------------|-----------|
| 30 x 3 mm   |              |           |
| 052.03.01   | 9 / 2 x 5,5  | RVS A2    |

## Verstelbaar duimdeel (duim 13mm) RVS A2

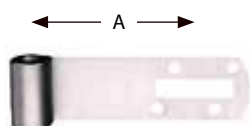

| Artikelcode | A (mm)   | Gat (mm) Ø | Afwerking |
|-------------|----------|------------|-----------|
| 052.04.01   | 45 - 75  | 4 x 5,5    | RVS A2    |
| 052.04.02   | 70 - 100 | 4 x 5,5    | RVS A2    |

## Staartgeheng RVS A4



| Artikelcode | L (mm) | D (mm) | Gat (mm) Ø | Afwerking |
|-------------|--------|--------|------------|-----------|
| 35 x 4 mm   |        |        |            |           |
| 052.05.01   | 300    | 14     | 3x8        | RVS A4    |
| 052.05.02   | 400    | 14     | 4x8        | RVS A4    |
| 052.05.03   | 500    | 14     | 4x8        | RVS A4    |
| 052.05.04   | 600    | 14     | 5x8        | RVS A4    |
| 052.05.05   | 700    | 14     | 5x8        | RVS A4    |
| 052.05.06   | 800    | 14     | 6x8        | RVS A4    |
| 40 x 5 mm   |        |        |            |           |
| 052.05.07   | 300    | 16     | 3x8        | RVS A4    |
| 052.05.08   | 400    | 16     | 4x8        | RVS A4    |
| 052.05.09   | 500    | 16     | 4x8        | RVS A4    |
| 052.05.10   | 600    | 16     | 5x8        | RVS A4    |
| 052.05.11   | 700    | 16     | 5x8        | RVS A4    |
| 052.05.12   | 800    | 16     | 6x8        | RVS A4    |
| 052.05.13   | 1000   | 16     | 7x8        | RVS A4    |
| 052.05.14   | 1200   | 16     | 8x8        | RVS A4    |
| 052.05.15   | 1500   | 16     | 9x8        | RVS A4    |

## L-geheng RVS A4

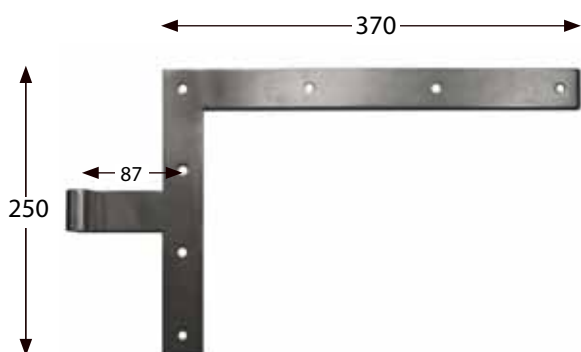

| Artikelcode | L/R | Gat (mm) Ø | Afwerking |
|-------------|-----|------------|-----------|
| 35 x 4 mm   |     |            |           |
| 052.06.01   | L   | 7x7,5      | RVS A4    |
| 052.06.02   | R   | 7x7,5      | RVS A4    |

## T-geheng RVS A4

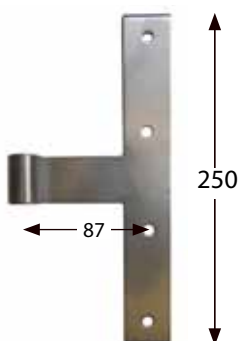

| Artikelcode | Gat (mm) Ø | Afwerking |
|-------------|------------|-----------|
| 35 x 4 mm   |            |           |
| 052.07.01   | 4x7,5      | RVS A4    |

# Luiksluitingen en vastzetters

## Overvalsluiting 1 RVS A4

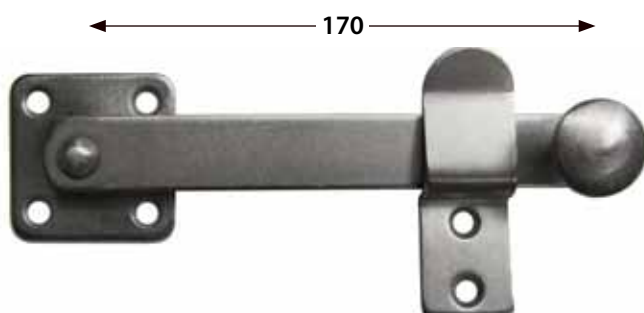

| Artikelcode | Gat (mm) Ø | Afwerking |
|-------------|------------|-----------|
| 081.01.05   | 6x4        | RVS A4    |

## Overvalsluiting 3 RVS A2

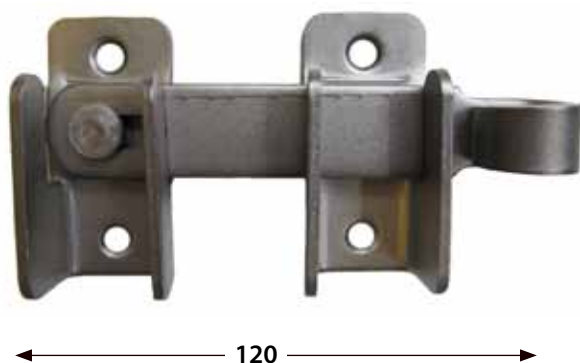

| Artikelcode | Gat (mm) Ø | Afwerking |
|-------------|------------|-----------|
| 081.11.03   | 4x4,5      | RVS A2    |

## Overvalsluiting groot RVS A2



| Artikelcode | Gat (mm) Ø    | Afwerking |
|-------------|---------------|-----------|
| 053.01.01   | 8x6/2x11/2x12 | RVS A2    |

## Schuifgrendel RVS A4

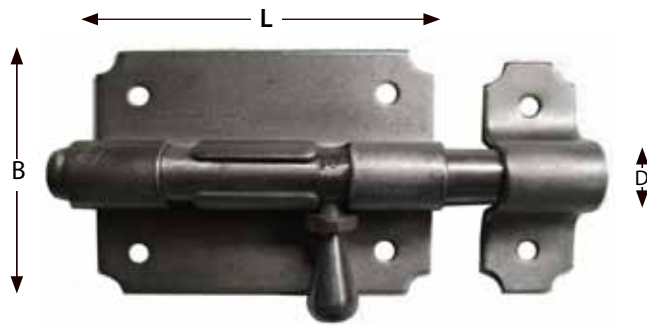

| Artikelcode | B  | L  | D  | Gat Ø | Afwerking |
|-------------|----|----|----|-------|-----------|
| 053.02.01   | 62 | 65 | 10 | 6x5   | RVS A4    |
| 053.02.02   | 68 | 80 | 12 | 6x5   | RVS A4    |
| 053.02.03   | 72 | 90 | 14 | 6x5   | RVS A4    |

## Schuifgrendel (afsluitbaar) RVS A4

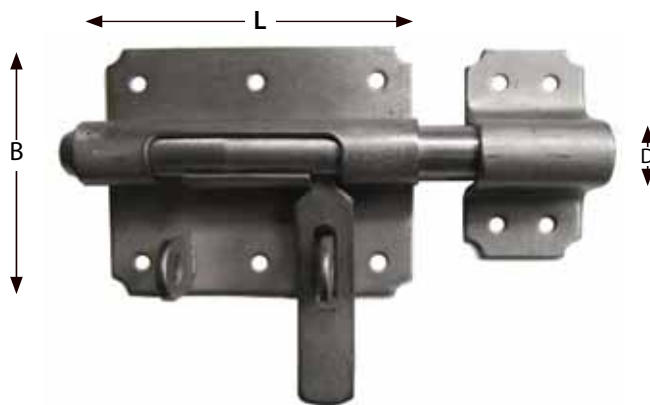

| Artikelcode | B  | L  | D  | Gat Ø | Afwerking |
|-------------|----|----|----|-------|-----------|
| 053.03.01   | 62 | 65 | 10 | 8x5   | RVS A4    |
| 053.03.02   | 68 | 80 | 12 | 8x5   | RVS A4    |
| 053.03.03   | 72 | 90 | 14 | 8x5   | RVS A4    |

## Schuifsluiting RVS A2

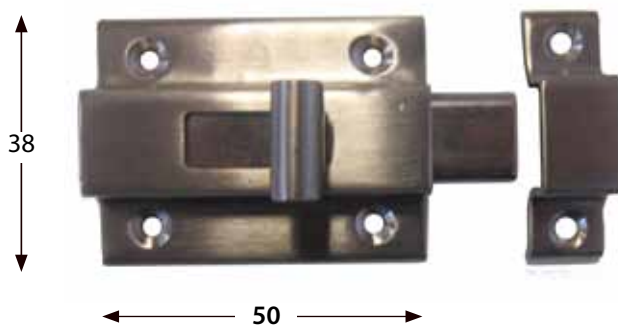

| Artikelcode | Gat (mm) Ø | Afwerking |
|-------------|------------|-----------|
| 053.04.01   | 6x3,5      | RVS A2    |

## Schuifsluiting met veer RVS A2

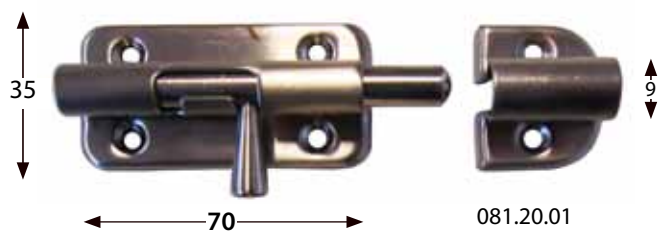

081.20.01

| Artikelcode | Gat Ø (mm) | Afwerking |
|-------------|------------|-----------|
| 053.05.01   | 6x4,5      | RVS A2    |
| 053.05.02   | 6x4,5      | RVS A2    |

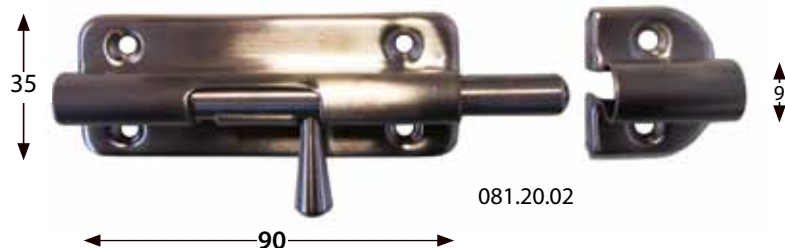

081.20.02

## Schuifsluiting 2 RVS A2

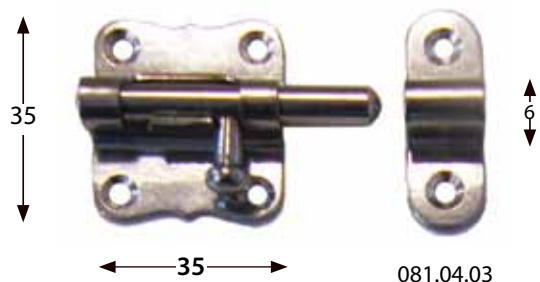

081.04.03

| Artikelcode | Gat Ø (mm) | Afwerking |
|-------------|------------|-----------|
| 081.04.03   | 6x3,5      | RVS A2    |
| 081.04.06   | 8x4,5      | RVS A2    |

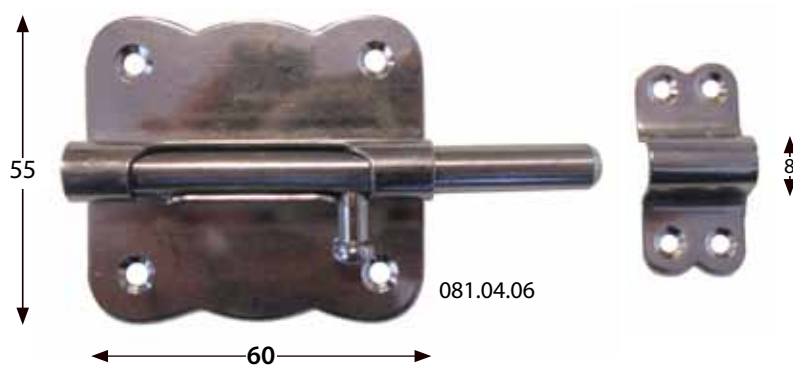

081.04.06



## Zinken Afstandhouder voor luikvastzetters

*Deze afstandhouder dient als aanslag voor het luik en is eenvoudig aan te passen aan de dikte van het luik.*



| Artikelcode | Afwerking |
|-------------|-----------|
| 082.10.02   | Zink      |

## RVS Afstandhouder voor luikvastzetters RVS A4



| Artikelcode | Afwerking |
|-------------|-----------|
| 082.09.03   | RVS A4    |

## Windval RVS A4

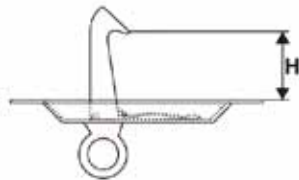

| Artikelcode | H (mm) | Afwerking |
|-------------|--------|-----------|
| 054.01.01   | 55     | RVS A4    |

## Staartgrendel RVS A4



| Artikelcode | L (mm) | Afwerking |
|-------------|--------|-----------|
| 054.02.01   | 400    | RVS A4    |

## RVS herderinnekopje RVS A2

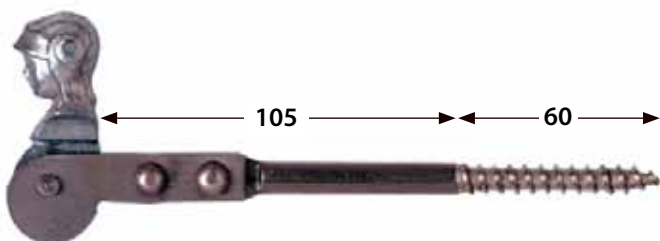

| Artikelcode | Afwerking |
|-------------|-----------|
| 082.02.01   | RVS A2    |

## Luikwervel 1 RVS A4



| Artikelcode | L (mm) | Afwerking |
|-------------|--------|-----------|
| 082.03.07   | 50     | RVS A4    |

## Bascule kantschuif RVS A2



| Artikelcode | Diepte (mm) | Afwerking |
|-------------|-------------|-----------|
| 054.03.01   | 18          | RVS A2    |
| 054.03.02   | 18          | RVS A2    |



# Paumelles en scharnieren

## Scharnier RVS A2

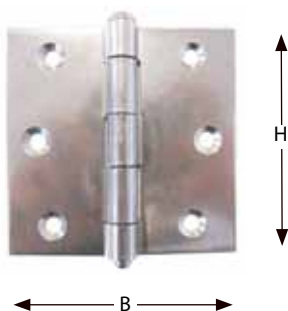

| Artikelcode | B (mm) | H (mm) | Dikte | Afwerking |
|-------------|--------|--------|-------|-----------|
| 055.02.01   | 30     | 30     | 0,8   | RVS A2    |
| 055.02.02   | 40     | 40     | 0,9   | RVS A2    |
| 055.02.03   | 50     | 50     | 1,0   | RVS A2    |
| 055.02.04   | 60     | 60     | 1,25  | RVS A2    |
| 055.02.05   | 80     | 80     | 1,5   | RVS A2    |
| 055.02.06   | 100    | 100    | 1,5   | RVS A2    |
| 055.02.07   | 60     | 60     | 1,8   | RVS A2    |
| 055.02.08   | 75     | 75     | 1,9   | RVS A2    |

## Bevestigingsmateriaal

Bevestigingsmateriaal nodig? Zie hoofdstuk 8.



# Voorbeelden

